

# scemama sa

Machines-outils / neuf et occasion - Machines-tools / second-hand  
Werkzeugmaschinen / neu und gebraucht

Route de Soleure 145  
CH-2504 Bienne / Switzerland  
Tél +41 (0)32 344 20 60

[www.scemama.ch](http://www.scemama.ch) [info@scemama.ch](mailto:info@scemama.ch)



## SERIE D D-SERIES

# C.B.Ferrari

[www.cbfeffari.com](http://www.cbfeffari.com)

designed and manufactured in Italy





**C.B.Ferrari**

# TRADITION **AND** INNOVATION

## L'AZIENDA **COMPANY**

Dal 1966 la costante innovazione, l'orientamento alle massime prestazioni e l'altissima precisione dei prodotti, riconosciuta e consolidata nel mercato per una vasta gamma di applicazioni, hanno portato C.B.Ferrari a ricoprire una posizione di leadership a livello mondiale nella costruzione di Centri di lavoro a CNC a 5 assi di precisione.

Attualmente C.B.Ferrari opera con due stabilimenti produttivi in Italia, secondo paese in Europa e quarto nel mondo per la produzione di macchine utensili. 160 dipendenti qualificati e motivati, forti di una lunga tradizione nel settore della meccanica di precisione, progettano e producono internamente tutte le parti della macchina compresi elettro-mandrini e tavole girevoli, garantendo nel tempo una straordinaria qualità e affidabilità.

Con oltre 4300 macchine installate con successo in tutto il mondo e l'ausilio di una fitta ed efficiente rete di vendita e di assistenza, C.B.Ferrari assicura ai propri Clienti il massimo supporto alla produzione e l'ottenimento di risultati che rappresentano lo stato dell'arte in termini di precisione e prestazioni.

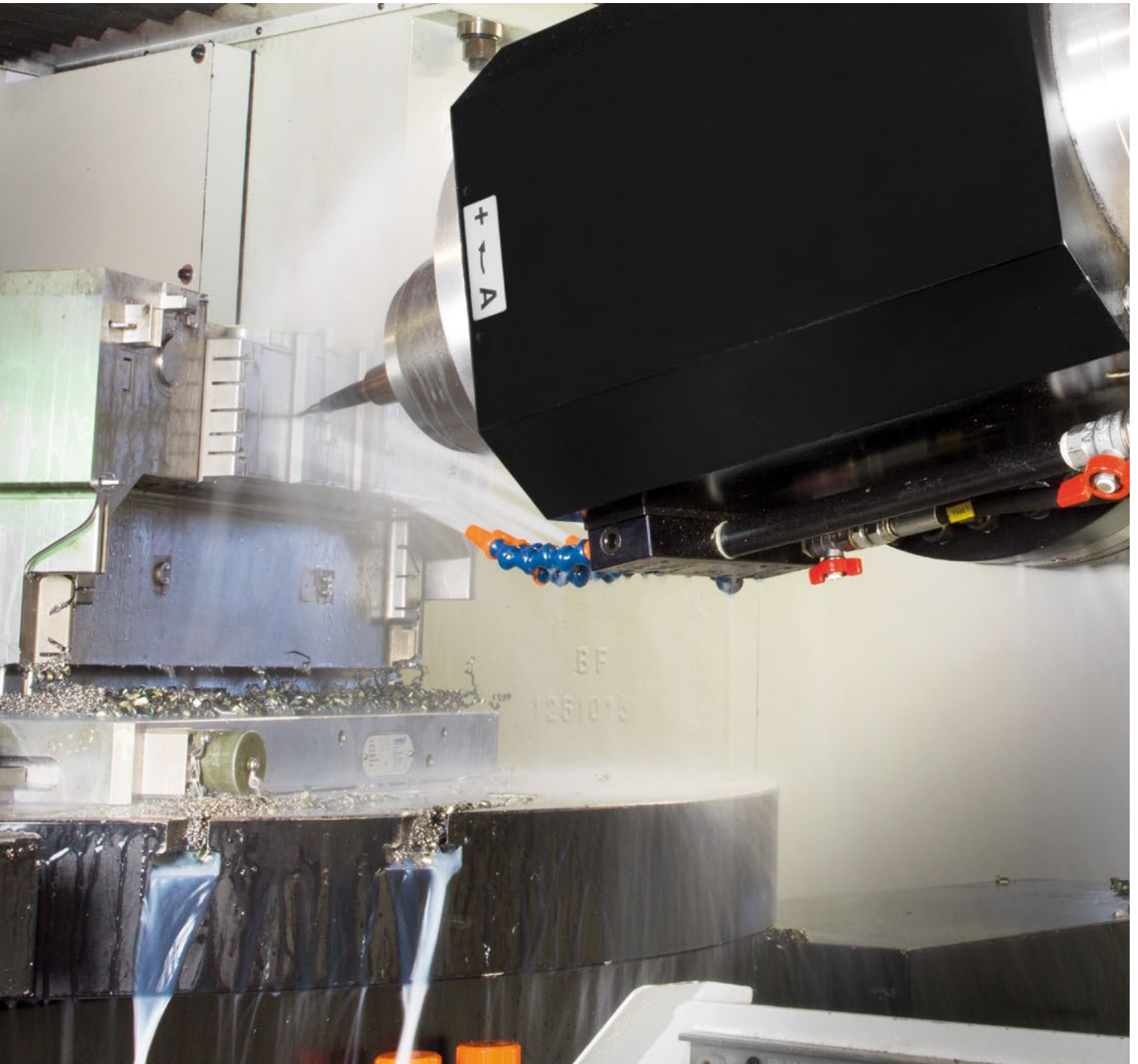

Since 1966 constant innovation, performance based approach and market recognized and consolidated superior accuracy, achieved in a wide variety of manufacturing applications, have led C.B.Ferrari to a world leading position in high precision 5-Axes CNC machining centers solutions.

Currently C.B.Ferrari operates with two manufacturing facilities in Italy, the second major machine manufacturing country in Europe and the fourth in the World. 160 skilled and highly motivated employees, enjoying the homeland long-standing tradition in precision mechanics, design and manufacture all machines in house including electro-spindles and rotary tables, ensuring extraordinary quality and reliability over the time.

With over than 4300 machines successfully installed worldwide, supported by a close and prompt sales and service network, C.B.Ferrari ensures its customers the ultimate manufacturing support, achieving state-of-the-art results in terms of accuracy and performances.

# C.B.Ferrari

## SERIE D D-SERIES

La **SERIE D** è un Centro di lavoro verticale ad alta velocità e precisione del tipo a portale fisso.

La sua struttura particolarmente rigida realizzata completamente in ghisa, possiede un elevato coefficiente di smorzamento ed una grandissima stabilità dimensionale.

La **SERIE D** raggiunge i migliori standard di accuratezza richiesti dal mercato. Grazie all'elevata dinamica degli assi è inoltre in grado di raggiungere altissime velocità, associate ad elevate precisioni di lavorazione.

Grazie all'elevata potenza e coppia degli elettromandri, progettati e costruiti da C.B. Ferrari, è possibile eseguire con la massima efficienza, sia lavorazioni di sgrossatura che di finitura.

L'integrazione della tavola girevole e della testa continua, consente alla macchina di ottenere una grande fluidità di movimento ed altissime finiture superficiali con 5 assi continui.

La **SERIE D** viene equipaggiata con i nuovi CNC Siemens 840D sl o Heidenhain iTNC 530, che garantiscono altissime prestazioni, affidabilità, sicurezza e stabilità grazie ad un'interfaccia grafica di semplice utilizzo per l'operatore. C.B.Ferrari grazie a sistemi di taratura proprietari di ultima generazione, è in grado di ottenere tempi ciclo considerevolmente più veloci rispetto ad altre soluzioni, in particolare per la lavorazione di stampi ed attrezzature, elementi per il settore aeronautico, automotive ed energetico.

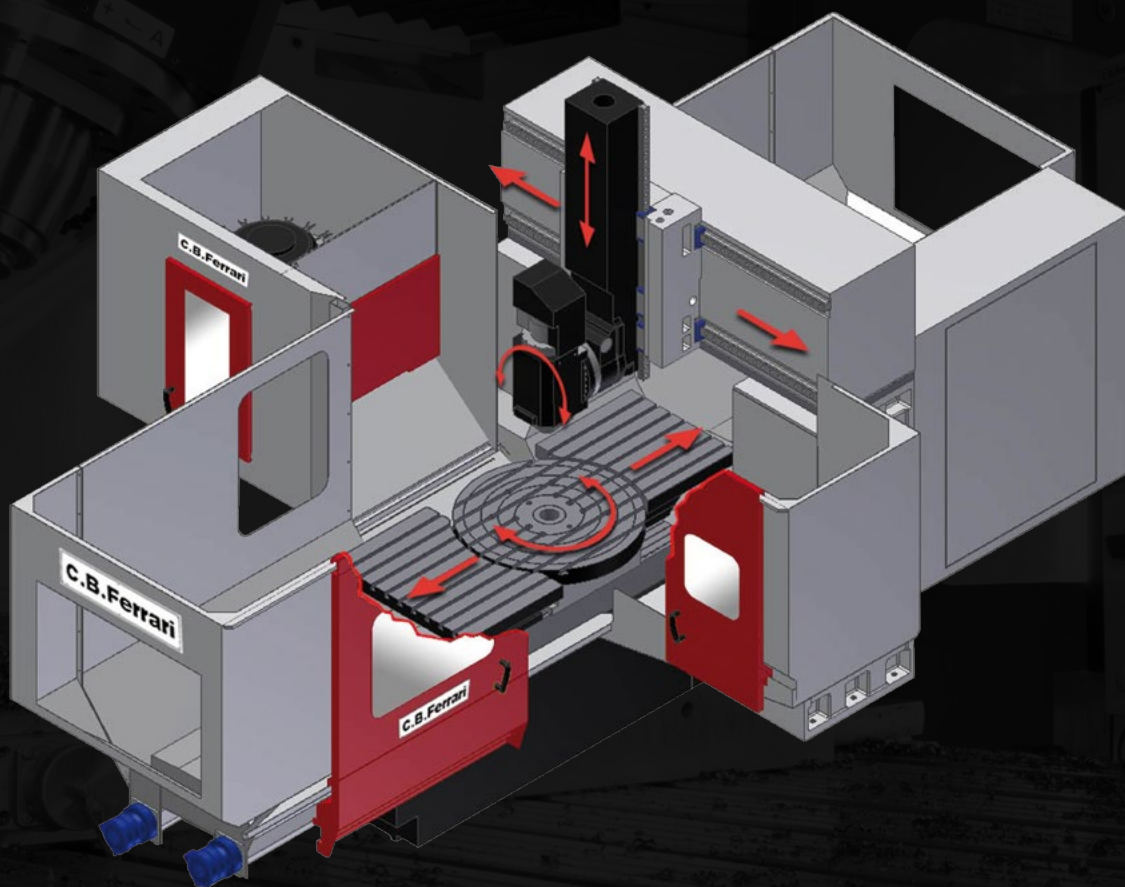



The **D-SERIES** is a high speed and high precision portal machining center. Its cast iron stiff structure express high damping and great dimensional stability.

The D-SERIES allows the highest accuracy required by the market. Thanks to the high axes dynamic it is able to reach high speeds, combined with best precision.

With the high power and torque of the electrospindles, designed and built by C.B. Ferrari, on D-SERIES it is possible to perform both finishing and roughing processes achieving maximum efficiency. The integration of the rotary table and the continuous tilting head, allows the D-SERIES to achieve motion smoothness and extremely high surface finishes.

The D-SERIES can be either equipped with Siemens 840D-sl or Heidenhain iTNC 530 CNC providing a stable, secure and reliable performance with an operator-friendly graphical user interface. C.B. Ferrari proprietary, next generation, performance based tuning system, delivers the fastest cycle times on dies & moulds, power generation, automotive and aerospace elements, compared to other solutions.

# SERIE D D-SERIES

**CENTRI DI LAVORO A PORTALE**  
**PORTAL MACHINING CENTER**

**scemama sa**

Machines-outils / neuf et occasion - Machines-tools / second-hand  
Werkzeugmaschinen / neu und gebraucht

Route de Soleure 145  
CH-2504 Biemme / Switzerland  
Tél +41 (0)32 344 20 60

[www.scemama.ch](http://www.scemama.ch) [info@scemama.ch](mailto:info@scemama.ch)

## SERIE D D-SERIES

# CARATTERISTICHE FEATURES

<b>CORSE SLIDE TRAVELS</b>	<b>D230</b>	<b>D420</b>	<b>D422</b>	<b>D430</b>	<b>D432</b>
X - Longitudinale <b>Longitudinal</b> (mm)	1600	2000	2000	3000	3000
Y - Trasversale <b>Cross</b> (mm)	1600	1600	2200	1600	2200
Z - Verticale <b>Vertical</b> (mm)	820				
Z - Verticale <b>Vertical</b> (mm) OPZIONE <b>OPTION</b>	-	1000			
<b>SISTEMA DI MISURA MEASURING SYSTEM</b>					
Righe ottiche assolute Heidenhain <b>Absolute optical linear scales</b>					
<b>ASSI AXES</b>	<b>D230</b>	<b>D420</b>	<b>D422</b>	<b>D430</b>	<b>D432</b>
Rapidi <b>Feed rates</b> XYZ (m/min)	40				
Spinta <b>Thrust</b> (N)	20000				
<b>ACCELERAZIONE ACCELERATION</b>	<b>D230</b>	<b>D420</b>	<b>D422</b>	<b>D430</b>	<b>D432</b>
Lineare <b>Linear</b> XYZ (m/s <sup>2</sup> )	5				
<b>UNITÀ DI COMANDO CNC-CONTROL</b>	<b>D230</b>	<b>D420</b>	<b>D422</b>	<b>D430</b>	<b>D432</b>
Heidenhain	iTNC 530				
Siemens	840D sl				
Elexa	E580				
<b>MAGAZZINO UTENSILI TOOL CHANGER</b>	<b>D230</b>	<b>D420</b>	<b>D422</b>	<b>D430</b>	<b>D432</b>
Tipo a ruota mobile <b>Movable wheel magazine type</b>					
Posizioni <b>Positions</b> (V40-HSKA63/V50)	30/20				
Tempo truciolo/truciolo <b>Changing time chips/chips</b> (s)	10	10	12	10	12
Lunghezza Max. utensile <b>Max. tool length</b> (mm) (V40-HSKA63/V50)	250				
Diametro Max. utensile <b>Max. Tool diameter</b> (mm) (V40-HSKA63/V50)	100/125				
Peso Max. utensile <b>Max tool weight</b> (kg)	5				
Tipo a catena con braccio di scambio <b>Chain type with exchanging arm</b>					
Posizioni <b>Positions</b> (V40-HSKA63/V50)	60/40				
Tempo truciolo/truciolo <b>Changing time chips/chips</b> (s)	10	10	12	10	12
Lunghezza Max. utensile <b>Max. tool length</b> (mm)	320				
Diametro Max. utensile <b>Max. Tool diameter</b> (mm)	100/125				
Peso Max. utensile <b>Max tool weight</b> (kg)	5				
<b>TAVOLA GIREVOLE 1 ASSE 1 AXIS ROTARY TABLE</b>	<b>D230</b>	<b>D420</b>	<b>D422</b>	<b>D430</b>	<b>D432</b>
Superficie di bloccaggio <b>Clamping area</b> (mm)	ø 1000	ø 1000 /1200			
Velocità <b>Speed</b> (rpm) A	8				
<b>DIMENSIONI E PESI DIMENSION AND WEIGHTS</b>	<b>D230</b>	<b>D420</b>	<b>D422</b>	<b>D430</b>	<b>D432</b>
Dimensioni <b>Dimensions</b> (mm) Max.	6200x6200	6350x7300		8000x7300	
	H=4450				
Peso <b>Weight</b> (kg)	15000	18000	19000	21000	22000
Potenza installata <b>Rating power</b>	45				

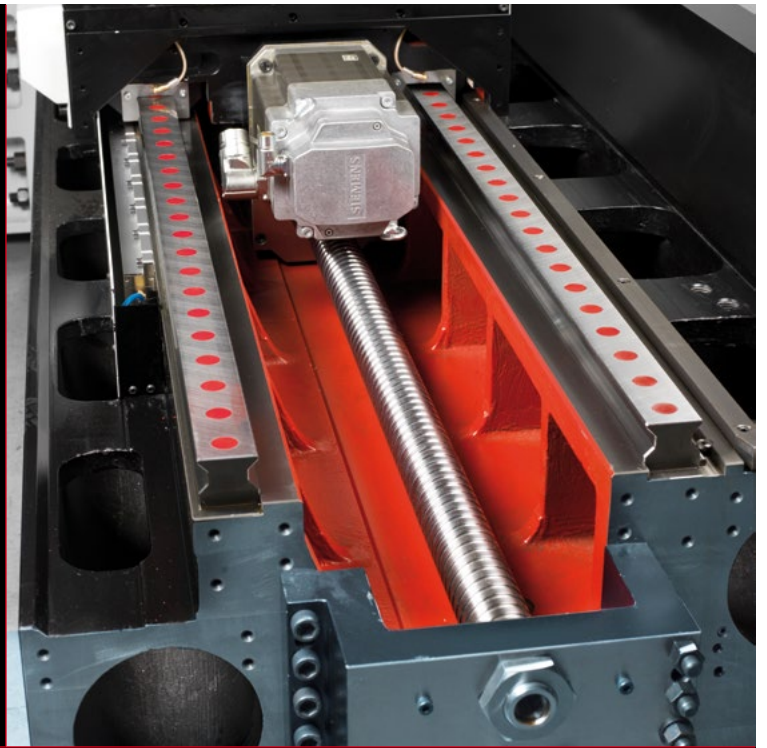
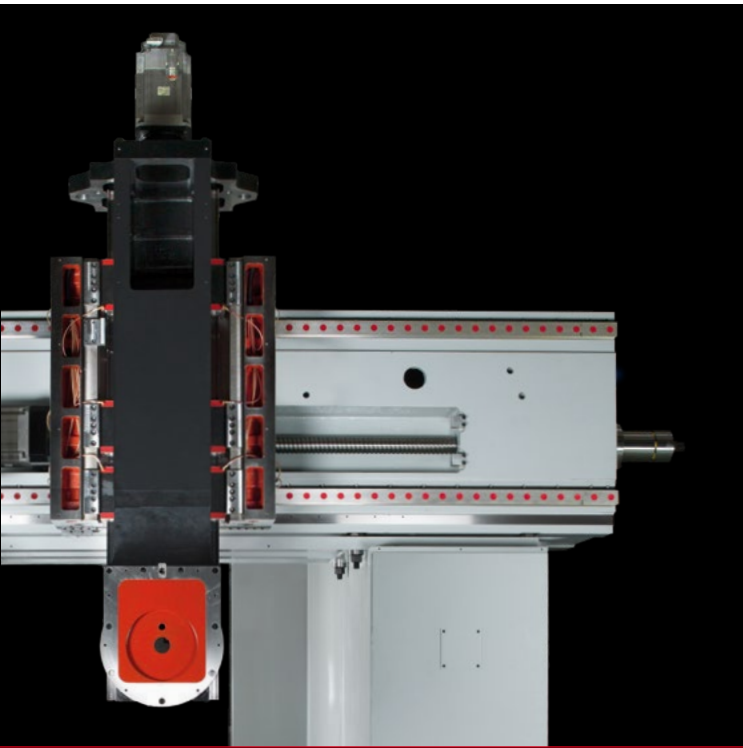

D230

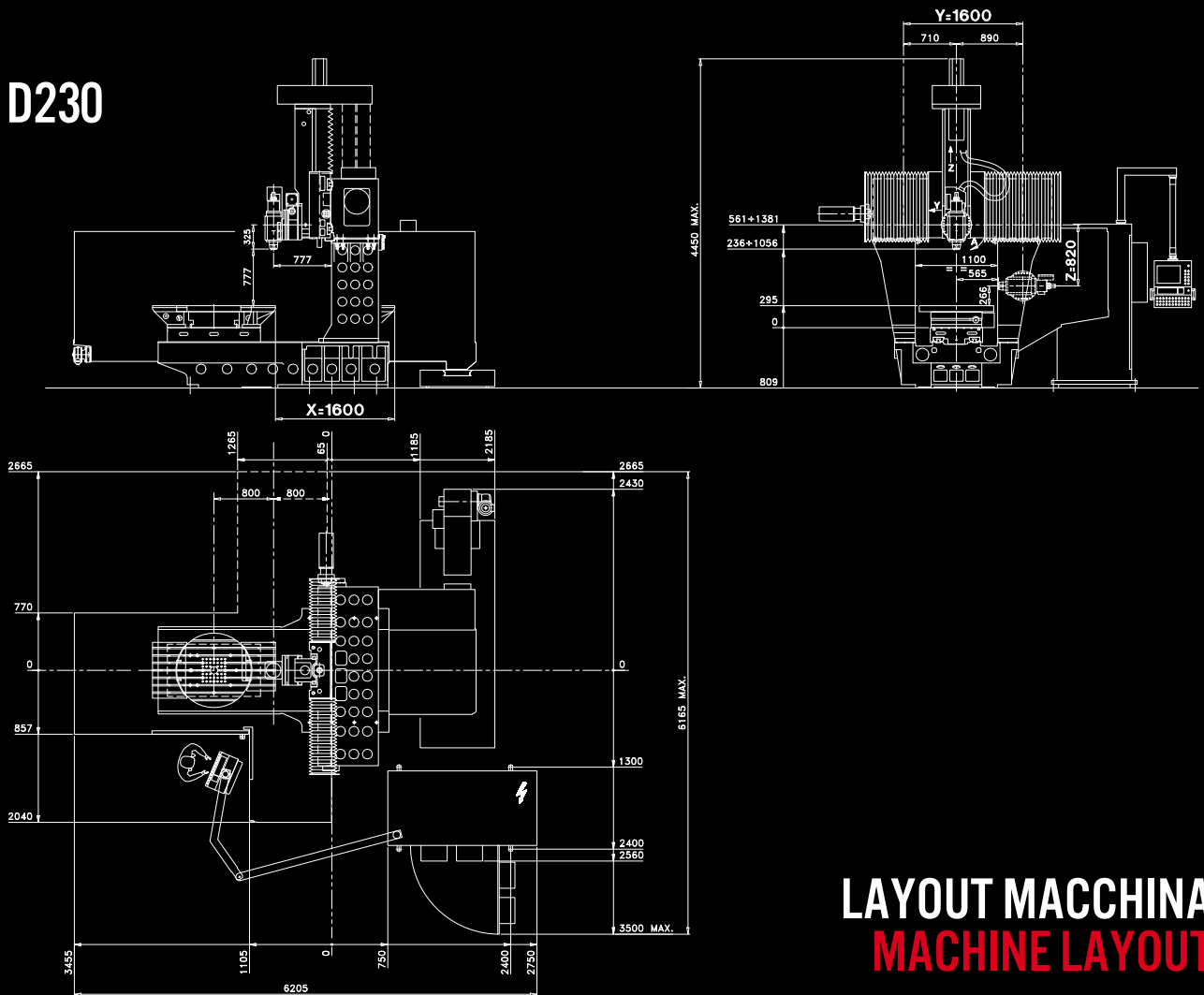

LAYOUT MACCHINA  
MACHINE LAYOUT

# D420

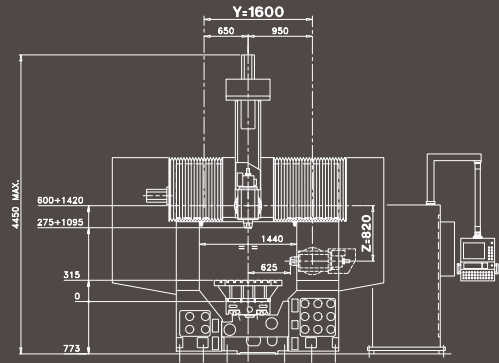
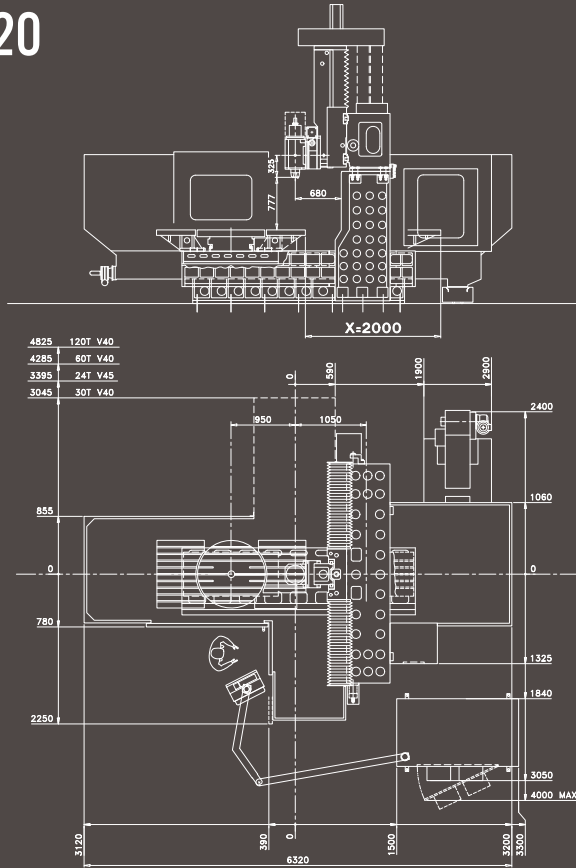

## Option Z=1000

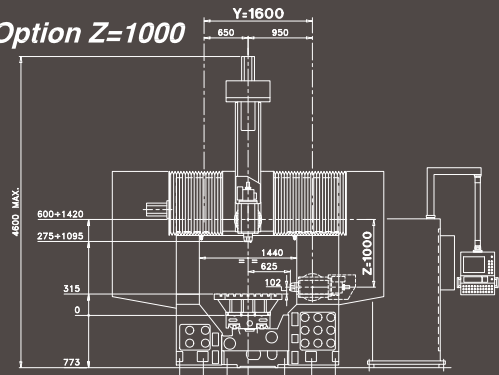

# D422

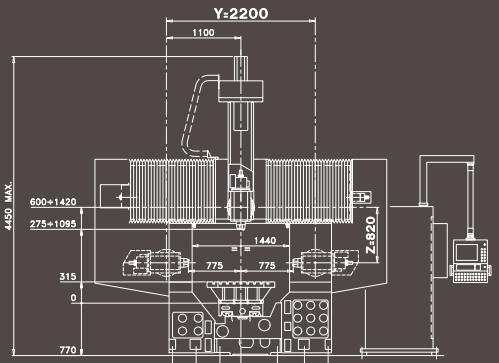
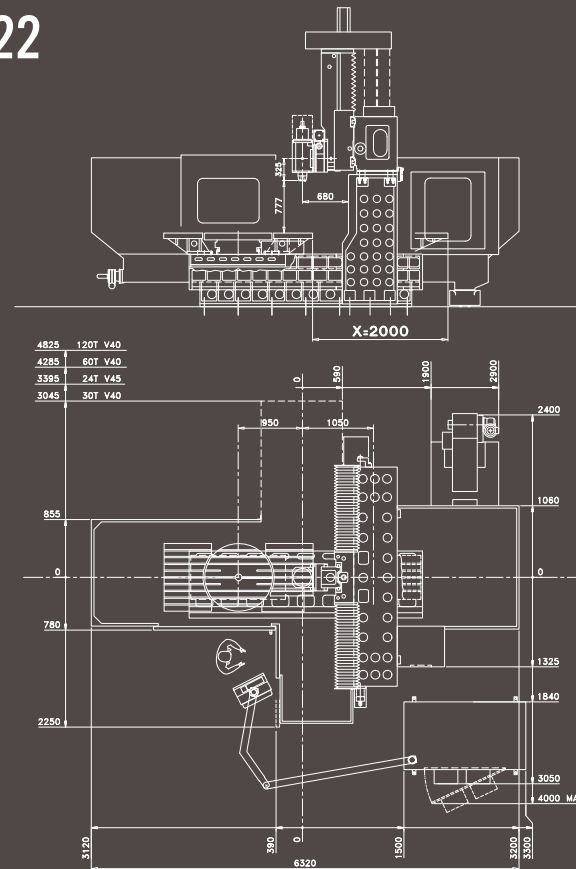

## Option Z=1000

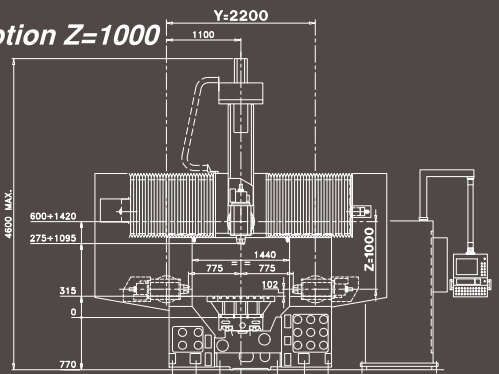



# D430

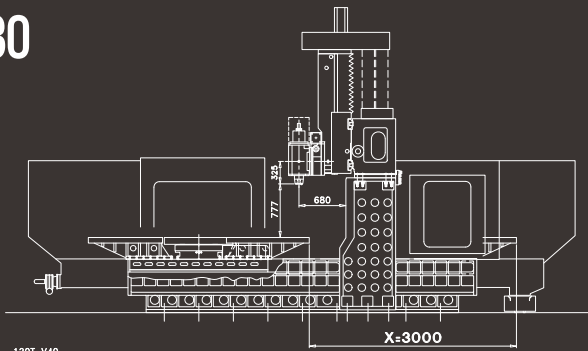

- 4825 120T V40
- 4285 60T V40
- 3395 24T V45
- 3045 30T V40

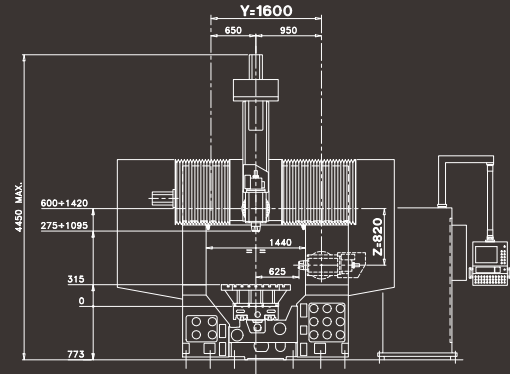
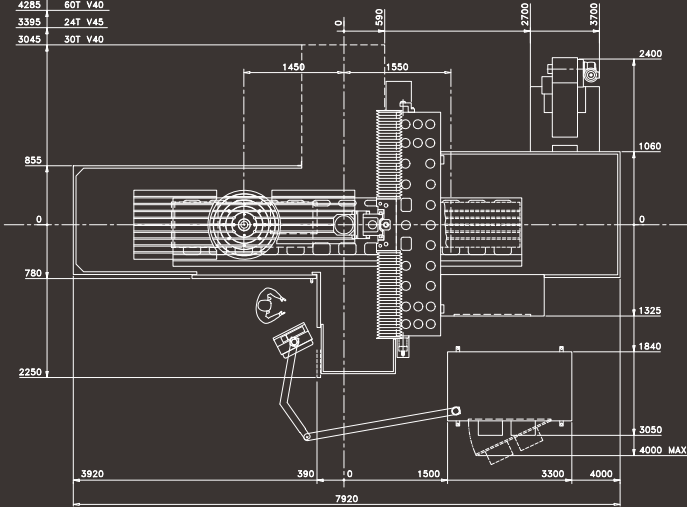

## Option Z=1000

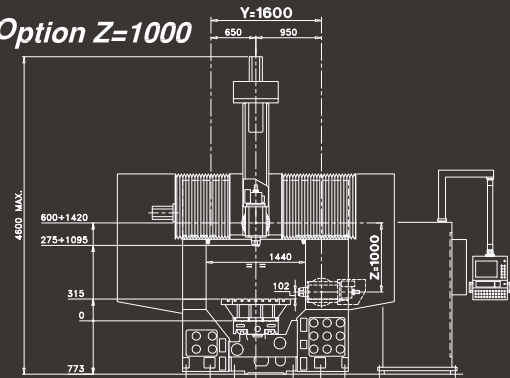

# D432

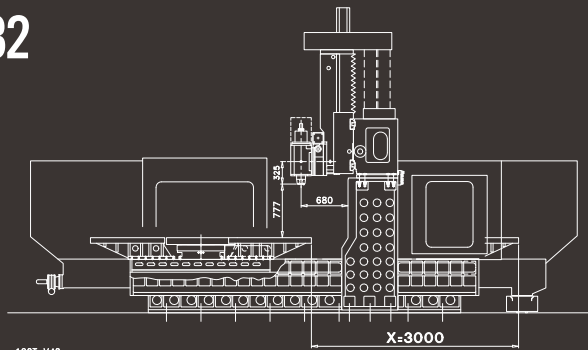

- 4825 120T V40
- 4285 60T V40
- 3395 24T V45
- 3045 30T V40

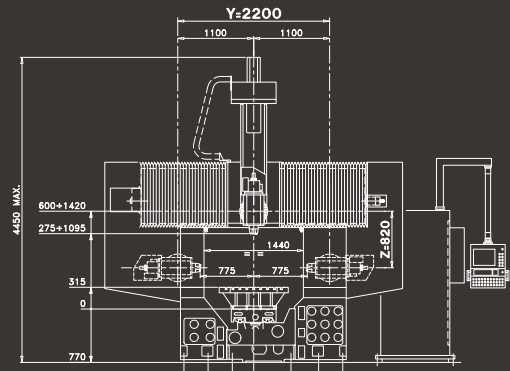
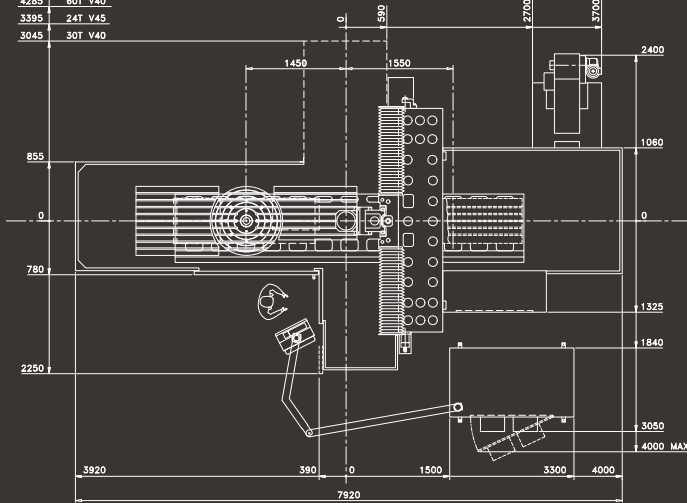

## Option Z=1000

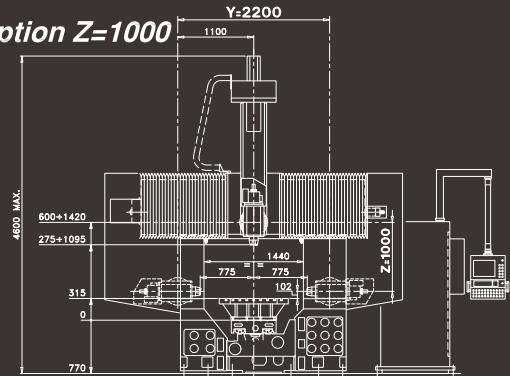

# TAVOLA GIREVOLE **ROTARY TABLE** TYPE 042032

Risoluzione **Resolution**  
 Precisione **Positioning accuracy**  
 Velocità asse A **A axis speed**  
 Coppia lavoro **Working torque**  
 Peso max del pezzo **Max workpiece weight**

0.0001°  
 (vedi **see** doc. 099004)  
 0÷8  
 2200 Nm  
 3200 kg

## PIATTAFORMA **FACEPLATE**

Ø 1000x80  
 Ø 1000x100  
 Ø 1200x100

Type 042004  
 Type 042007  
 Type 042006

PER FOR  
**D420/D422**

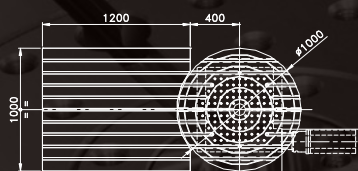

Piattaforma **Faceplate** Ø1000x100  
 Semitavola fissa **Fixed halftable**

Type 042007  
 Type 041423

PER FOR  
**D430/D432**

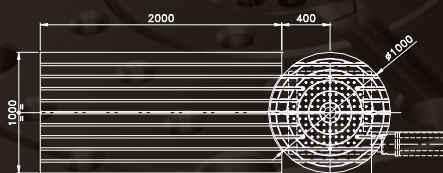

Piattaforma **Faceplate** Ø1000x100  
 Semitavola fissa **Fixed halftable**

Type 042007  
 Type 041433

PER FOR  
**D230**



Piattaforma **Faceplate** Ø1000x80  
 Semitavola fissa sinistra **Fixed left halftable**  
 Semitavola fissa destra **Fixed right halftable**

Type 042004  
 Type 041422  
 Type 041421

PER FOR  
**D420/D422**

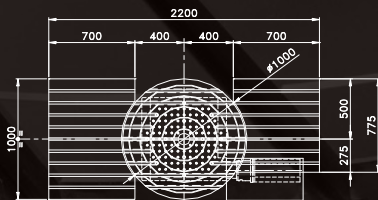

Piattaforma **Faceplate** Ø1000x100  
 Semitavola fissa sinistra **Fixed left halftable**  
 Semitavola fissa destra **Fixed right halftable**

Type 042007  
 Type 041424  
 Type 041425

PER FOR  
**D430/D432**

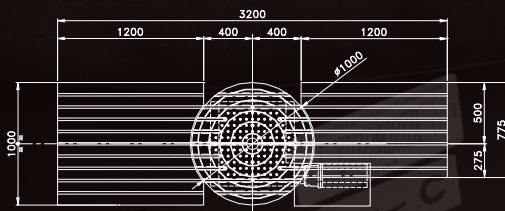

Piattaforma **Faceplate** Ø1000x100  
 Semitavola fissa sinistra **Fixed left halftable**  
 Semitavola fissa destra **Fixed right halftable**

Type 042007  
 Type 041423  
 Type 041419

# CNC DISPONIBILI AVAILABLE CONTROLS



Siemens 840D sl



Heidenhain iTNC 530

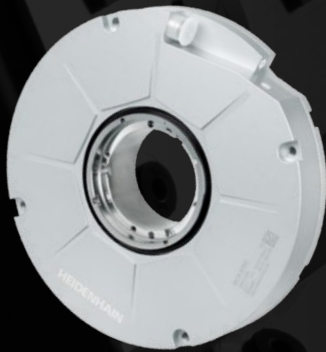

Tutti gli assi rotativi sono equipaggiati con encoder assoluti Heidenhain. Risoluzione 0,0001°

All rotary axes are equipped with Heidenhain absolute encoders. Resolution 0,0001°



Tutte le macchine sono equipaggiate con righe ottiche assolute Heidenhain

All machines are equipped with Heidenhain absolute linear scales.

# C.B.Ferrari

## SERIE D D-SERIES

# ELETTROMANDRINI ELECTROSPINDLES

C.B. Ferrari progetta e costruisce in autonomia tutti gli elettromandri con cui equipaggia le proprie macchine, offrendo considerevoli vantaggi ai propri clienti:

- Mandrini sostitutivi sempre disponibili
- Facilità di sostituzione con tempi di intervento minimi
- Costi di riparazione contenuti
- Fermi macchina ridotti

C.B. Ferrari design and manufactures in house all the electrospindles its machines are equipped with, offering remarkable advantages to its customers:

- Spare spindles always available
- Ease of replacement with minimum intervention time
- Low repair cost
- Reduced machine downtime

Cuscinetti a sfere ceramiche **Ceramic ball bearings**

Motore sincrono integrato **Integrated synchronous motor**

Funzionamento a temperatura controllata **Temperature controlled operation**

Refrigerazione a liquido **Liquid cooling system**

Ridottissimi tempi di accelerazione e frenata **Short acceleration and brake time**

Compensazione automatica della dilatazione termica lungo l'asse dell'utensile  
**Automatic compensation of thermal expansion along the tool axis**



20000 RPM  
28 kW  
63/83 Nm

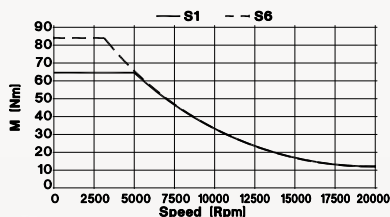
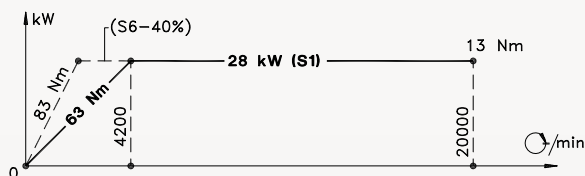

16000 RPM  
33 kW  
105/140 Nm

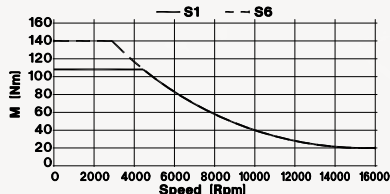
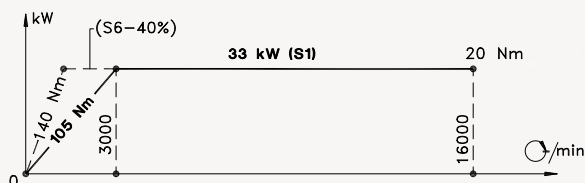

16000 RPM  
53.4/64 kW  
170/236 Nm

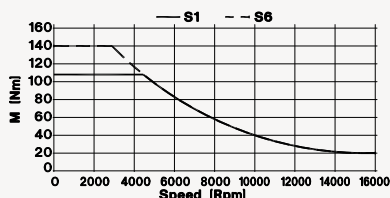
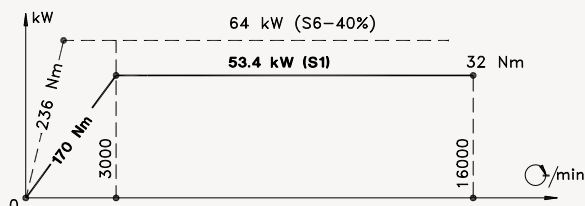

12000 RPM  
53.4/64 kW  
170/236 Nm

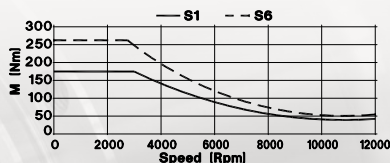
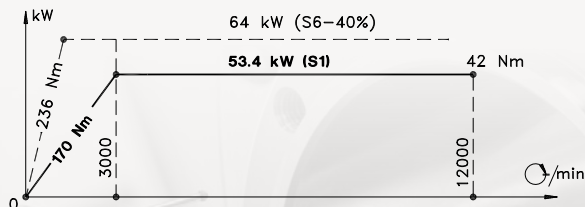

6500 RPM  
41.6/45 kW  
265/340 Nm

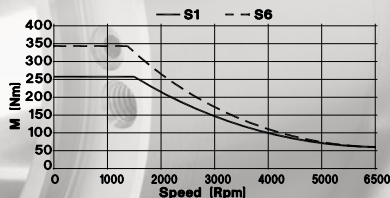
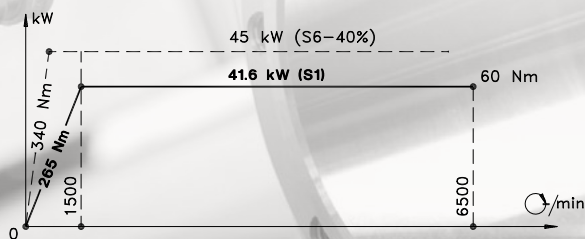

**TESTE INCLINEVOLI CONTINUE** **CONTINUOUS TILTING HEADS** Asse Axis: C = ± 91° - 3900 °/Min.

20000 RPM	ISO V40	28 kW	68/83 Nm	Type 051556
20000 RPM	HSK-A63	28 kW	68/83 Nm	Type 051557
16000 RPM	ISO V40	33kW	105/140 Nm	Type 050447
16000 RPM	HSK-A63	33 kW	105/140 Nm	Type 050478
16000 RPM	HSK-A63	53/64 kW	170/236 Nm	Type 051558
12000 RPM	ISO V50	53/64 kW	170/236 Nm	Type 051551
6500 RPM	ISO V50	42/45 kW	265/340 Nm	Type 050489

## SERIE D D-SERIES

# ACCESSORI ACCESSORIES

**LA MACCHINA PUÒ ESSERE EQUIPAGGIATA CON I SEGUENTI ACCESSORI A RICHIESTA**  
**THE MACHINE CAN BE EQUIPPED WITH THE FOLLOWING ACCESSORIES ON REQUEST**

Nastro evacuatore trucioli per alluminio/titanio **Chips conveyor for Aluminium/Titanium**

Aspiratore filtro **Exhaust filter**

Refrigerazione via mandrino a 75 bar **Through spindle coolant system 75 bar**

Refrigerazione utensile con aria **Tool blower air system (standard)**

Refrigerazione utensile con aria/olio **Tool blower air/oil system**

Tastatore 2D o 3D **2D or 3D Touch probe**

Apparecchio taratura utensili a contatto **Touch tool setting device**

Apparecchio taratura utensili Laser **Laser tool setting device**

Finestra rotante (rotoclear) **Spin window (rotoclear)**

Volantino remotato **Remote handwheel**

Altre opzioni disponibili su richiesta **Other options available on request**



**GRUPPO REFRIGERAZIONE VIA MANDRINO - 75 BAR**  
Vasca 500 l - Filtro tamburo

**THROUGH SPINDLE COOLANT GROUP - 75 BAR**  
500 lts tank - Drum filter



**GRUPPO CONTROLLO PEZZO 2D - 3D**  
**2D - 3D CONTROL PIECE GROUP**



**TARATURA UTENSILI LASER**  
**LASER TOOLS SETTING DEVICE**



**TARATURA UTENSILI A CONTATTO**  
**CONTACT TOOLS SETTING DEVICE**

# SOLUZIONI D'AUTOMAZIONE AUTOMATION SOLUTIONS

Sul Centro di lavoro **SERIE D** è possibile applicare caricatori automatici, che possono essere di produzione C.B.Ferrari oppure di altri fornitori esterni.

On the machining Center **D-SERIES** is possible to apply automatic loader, which can be produced by C.B.Ferrari or from external suppliers.

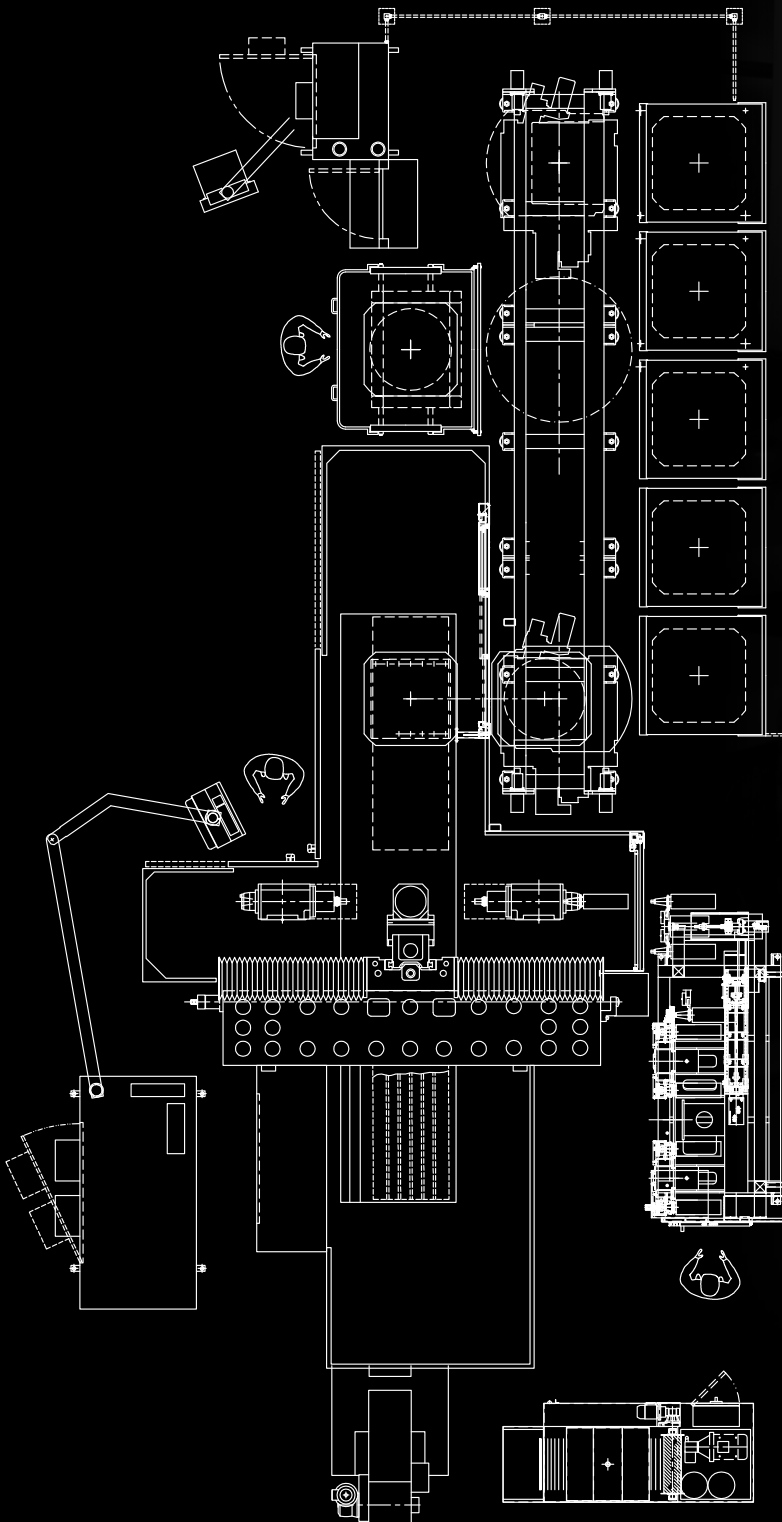

TRADITION **AND** INNOVATION



03.2016

**C.B. Ferrari**

www.cbfeerrari.com

SEDE DI MORNAGO **SITE OF MORNAGO**

Via Stazione, 116  
21020 MORNAGO (Va) - Italy

Tel.: +39 0331 903524  
Fax: +39 0331 903642  
cbferrari@cbferrari.com

SEDE DI MODENA **SITE OF MODENA**

Via Curtatona, 21  
41126 MODENA - Italy

Tel.: +39 059 281460  
Fax: +39 059 280113

**scemama sa**

Machines-outils / neuf et occasion - Machines-tools / second-hand  
Werkzeugmaschinen / neu und gebraucht

Route de Soleure 145  
CH-2504 Bienne / Switzerland  
Tél +41 (0)32 344 20 60

www.scemama.ch info@scemama.ch

designed and manufactured in Italy

